

1. Expand the frame with the adjustable feet pointed down.

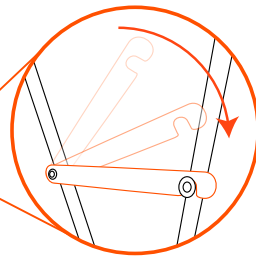

2. Lock the two metal support brackets to secure the frame open.

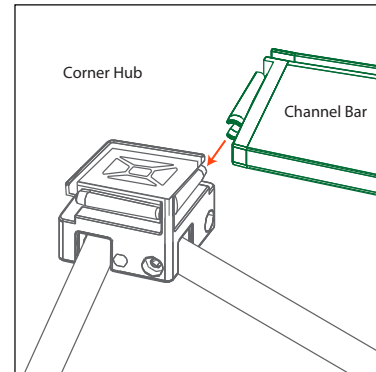

3. Install the 4 front channel bars and rear 4 back channel bars. The thinner edge goes toward the inside of the frame.

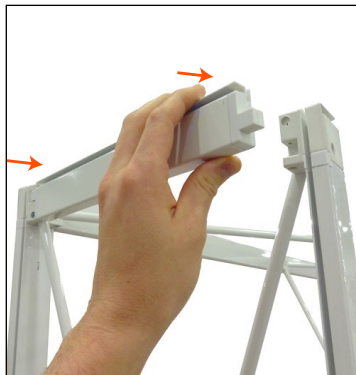

4. Snap the four endcap channel bars to the top and bottom sides of the frame.

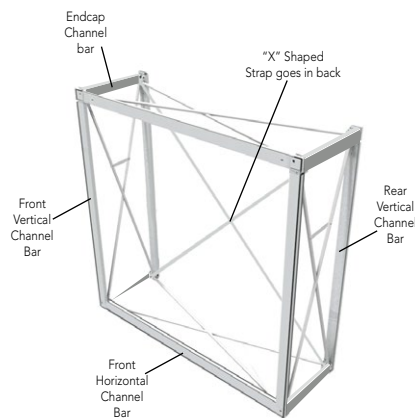
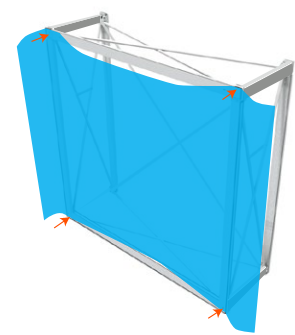
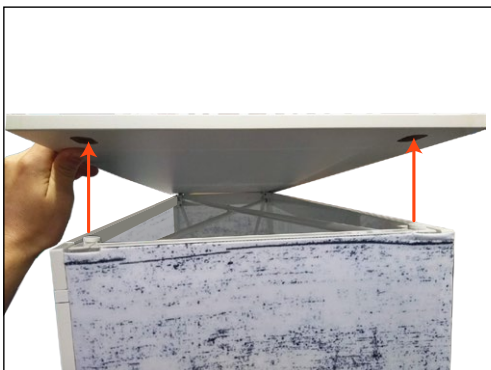

Diagram showing the locations of the channel bars required.



5. Install the wrap-around fabric graphics. See the following page for detailed graphic installation.



6. Set countertop on top (making sure the frame nubs go into the recesses).



7. Insert the shelf, latching the metal hooks onto the support brackets on each side of the frame.



Graphic Installation Instructions



Caution! Installing silicone-edged graphics is technique sensitive; Practice will shorten installation time.



Handle graphics with care with clean hands in a clean environment. Clean cloth or latex gloves are recommended.



How to Install SEG Graphics:

Turn and tuck the side of the graphic with the silicone welt into the SEG groove. The stitched edge goes into the groove first.

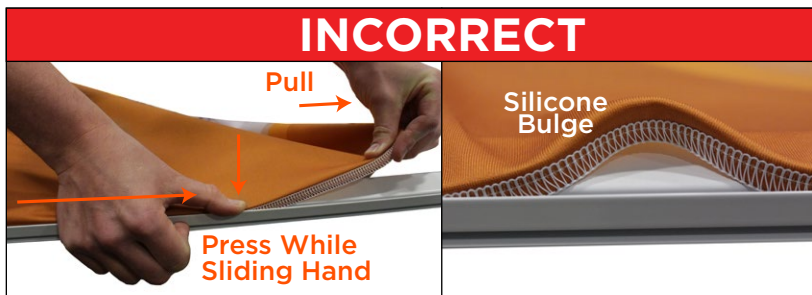

Pulling on the silicone welt during installation stretches the silicone and creates a bulge in the silicone welt that is difficult to correct smoothly.

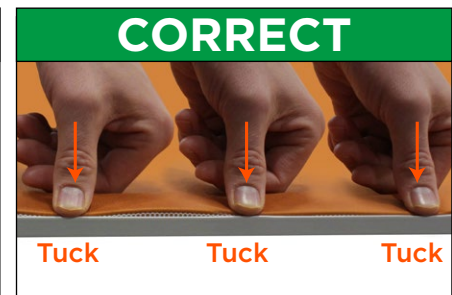

A series of tucks reduces excess silicone.

Installing Graphics with Wrap-Around Endcaps

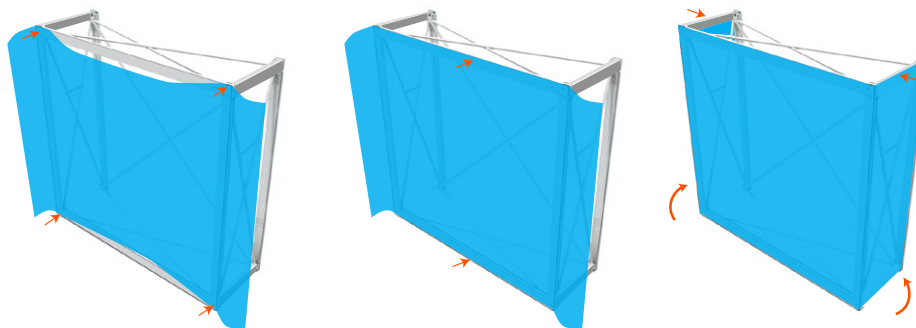

1. Tuck the graphics into each corner where there is a gap in the silicone welt.

The silicone welt tucks into the SEG groove facing forward from the front of the frame.

2. Complete tucking the front of the graphic.

3. Wrap the endcap around the sides of the counter and tuck into the rear side vertical SEG grooves. Complete endcap installation by tucking the remaining silicone into the SEG grooves.