

# Elements Display General Assembly Instructions

Note: Assembly is the same for all shapes and sizes of Elements Frames

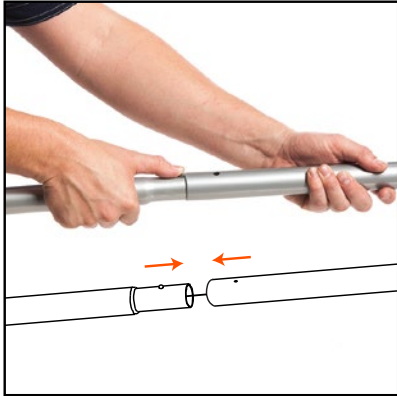

1. Straighten and assemble all bungee poles.

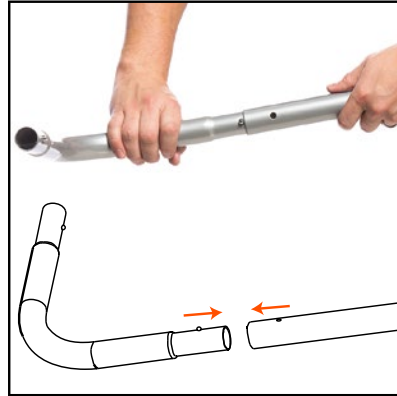

2. Connect poles to corners. (See diagram to on next page)

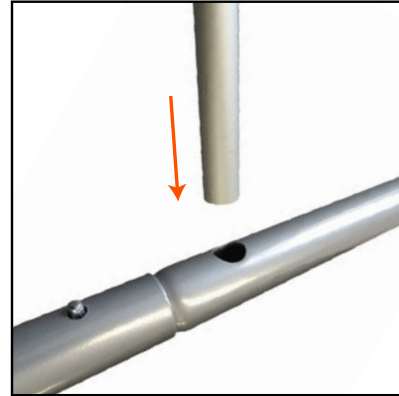

3. If your kit includes a center support pole, insert it into the corresponding holes, located in the top and bottom poles of the frame. Frames over 100" wide require support poles

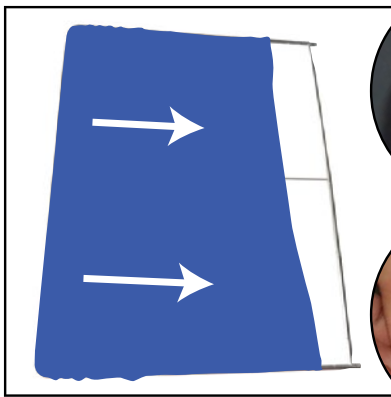

4. Lay frames down. Pull pillowcased graphic over frame and zip closed.

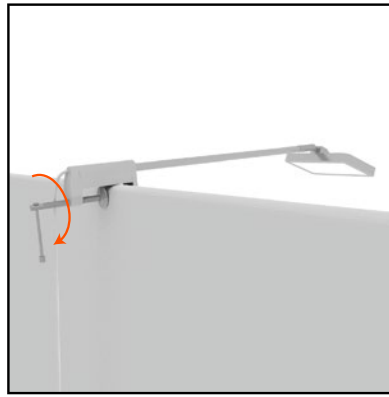

5. Clamp optional lights on top bar. Tip: Put lights on before standing the display up.

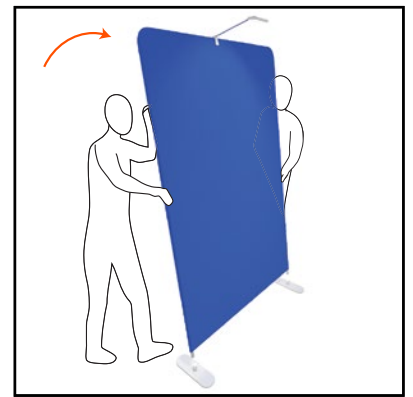

6. Stand frames up. Note: This step is easier with two people.



7a. If your kit includes a single foot, attach it to bottom of frame. Secure foot with locking pin.

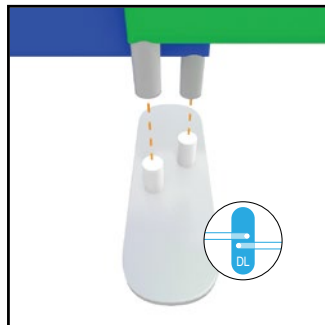

7b. If your kit includes a double foot labeled (DL), connect as seen above. Frame on right (shown in green above) attaches to the front foot nub and overlaps the back frame by approximately 3.5 inches.

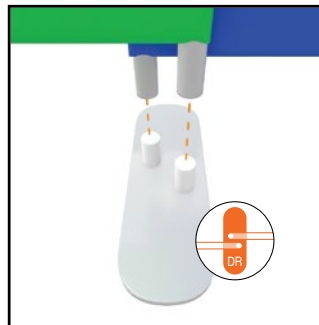

7c. If your kit includes a double foot labeled (DR), connect as seen above. Frame on left (shown in green above) attaches to the front foot nub and overlaps the back frame by approximately 3.5 inches.

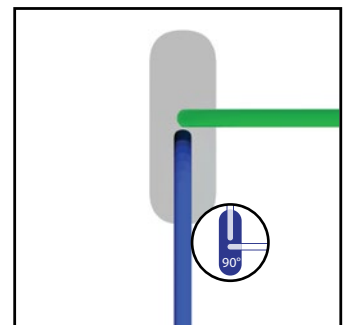

7d. If your kit includes a 90 degree foot labeled (90), connect as seen above. Frame on bottom (shown in blue above) should be placed at a right angle in relation to the adjacent frame. **Note:** This foot does *not* use locking pins.

Hardware is labeled as seen in diagram below:

