

1. Straighten and assemble all bungeed poles.

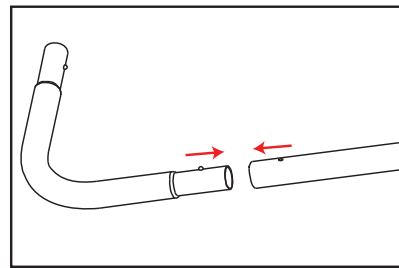

2. Assemble the frame by aligning the stickers as seen in the frame diagram above.

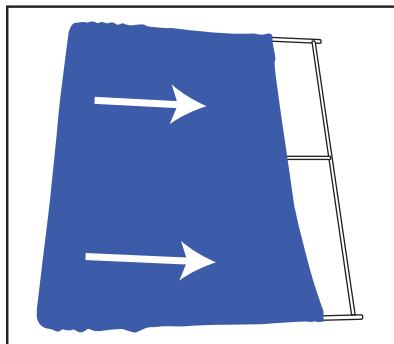

3. Pull pillowcase graphic over frame and zip bottom closed.

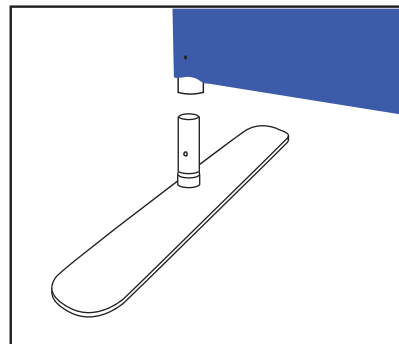

4. Attach the feet to the frame as seen in the diagram above.

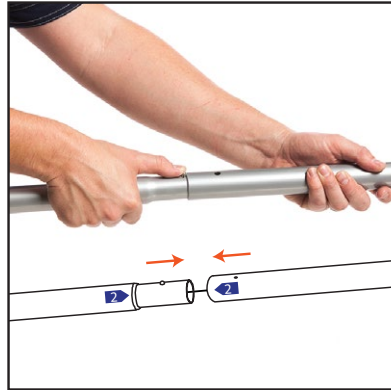
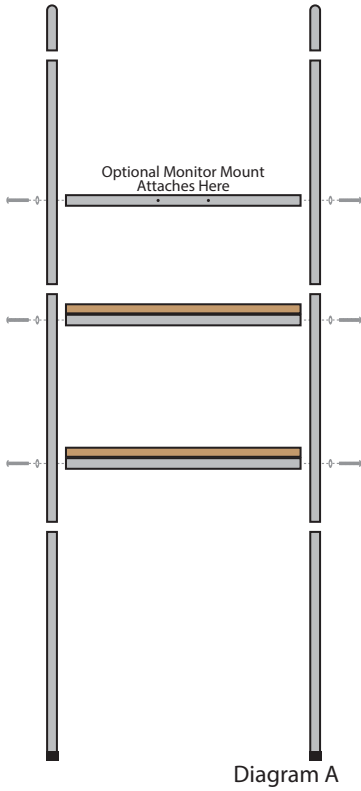

1. Matching the numbered stickers, assemble the frame as seen in Diagram A.



2. Using the provided 5mm allen wrench assemble the monitor and shelf supports.

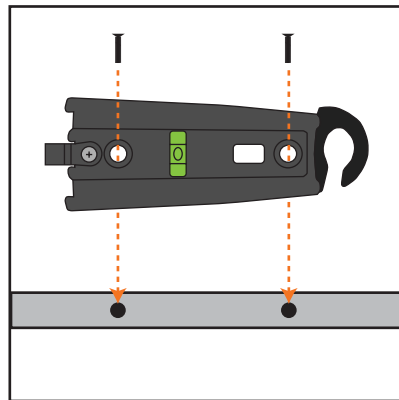

3. Screw bracket to horizontal support bar using the provided 4mm allen wrench. Ensure hook is facing downward on right.

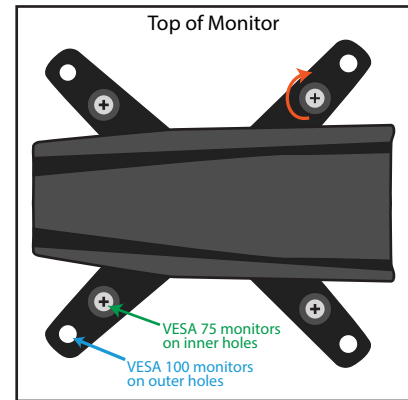

4. Mount the monitor bracket to back of monitor as shown above using a Phillips head screwdriver.



5. Slide the monitor into the bracket until it locks in place.



Monitor weight must not exceed 15 pounds.