

Note: Assembly is the same for all sizes of Graffiti displays

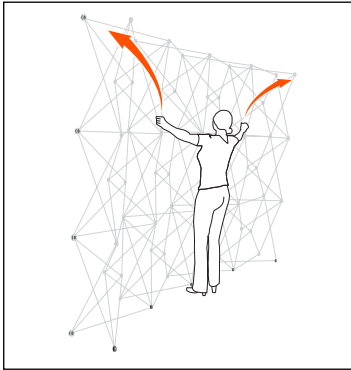

1. Expand the frames so they stand upright with the adjustable feet on the floor.

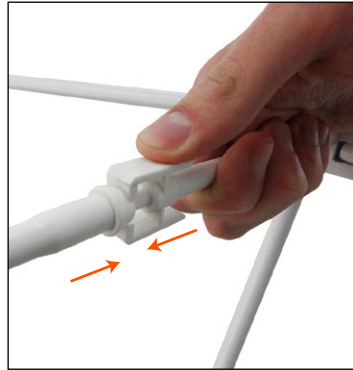

2. Push every connector together. Clips snap in place.

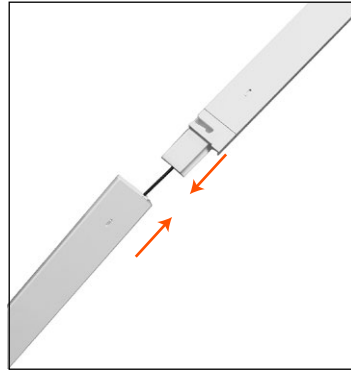

3. Assemble the channel bars. Slide the channel bar's end hook into the slot in the corner hub. See diagrams at the bottom of this page for channel bar locations.

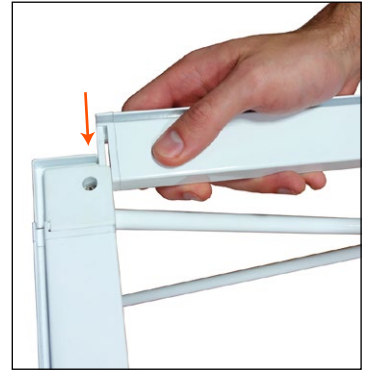

4. Snap the channel bars onto the silver nubs on the center hubs.

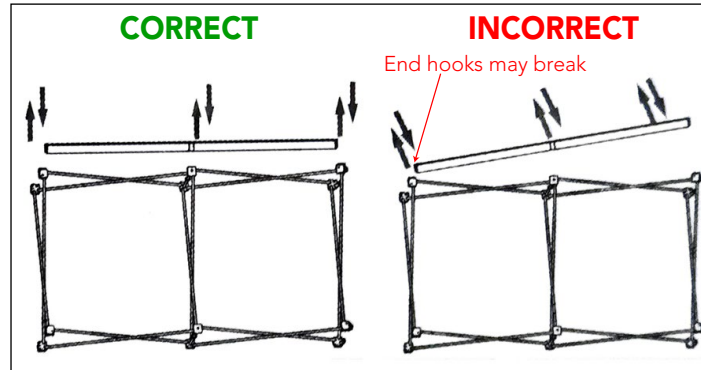

Warning: Handle channel bars with care. During installation or while dismantling, do not angle the channel bars. Angling channel bars applies stress to the end hook which may become damaged.

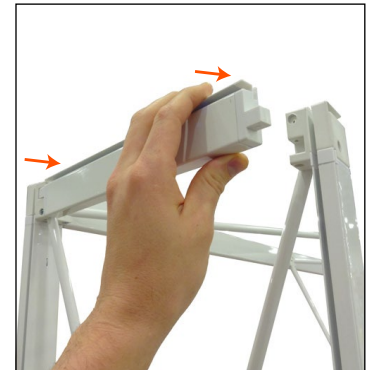

6. Snap four endcap channel bars to the top and bottom sides of the frame.

5. Slide the other end hook into the opposite corner hub.

Add back horizontal channel bars (shown in blue) for a double-sided display

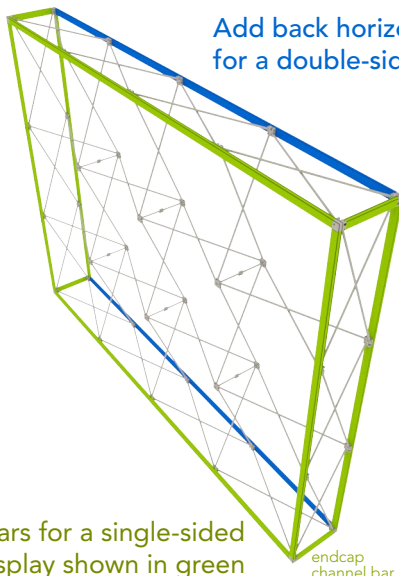

7. Install the graphic. See the following page for in-depth graphic installation guidelines.



8. Optional lights attach to the top channel bar with clear clips.

**Need Help?**  
Scan the QR code or go to [youtu.be/MoM8PsJlrS8](https://youtu.be/MoM8PsJlrS8) to watch an assembly video



## Graphic Installation Instructions



Caution! Installing silicone-edged graphics is technique sensitive; Practice will shorten installation time.



Handle graphics with care with clean hands in a clean environment. Clean cloth or latex gloves are recommended.

Graphic installation may be easier with the frame laying on the ground.



How to Install SEG Graphics:  
Turn and tuck the side of the graphic with the silicone welt into the SEG groove.  
The stitched edge goes into the groove first.



Pulling on the silicone welt during installation stretches the silicone and creates a bulge in the silicone welt that is difficult to correct smoothly.

A series of tucks reduces excess silicone.

## Installing Graphics with Endcaps

1. Start tucking the graphic in one corner.  
Start after the gap in the silicone.

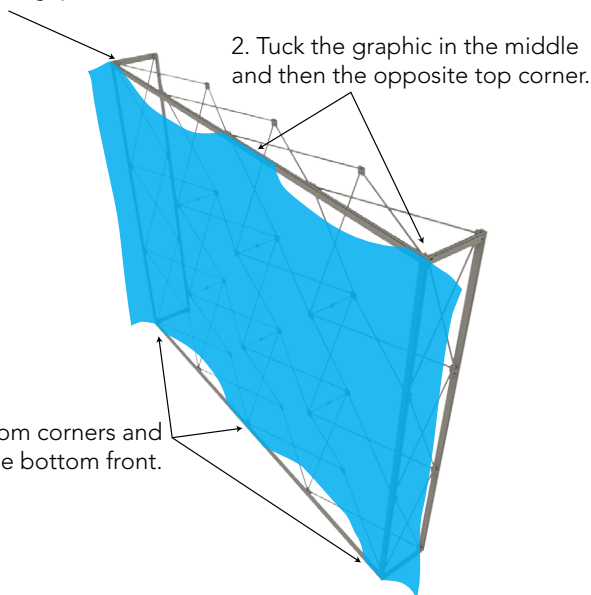

3. Tuck the bottom corners and the middle of the bottom front.

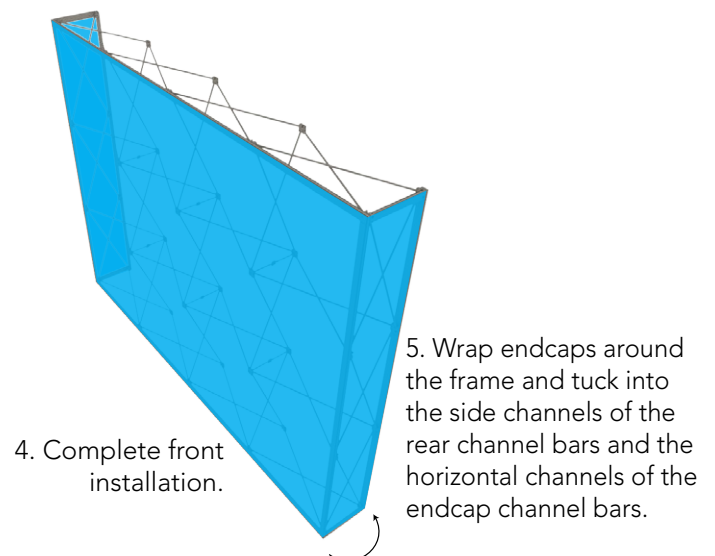

## Frame Top Cap Instructions

1. Align frames together in desired orientation. See diagrams below to select the proper top cap.
2. Adjust the adjustable feet on the frames as needed to align.

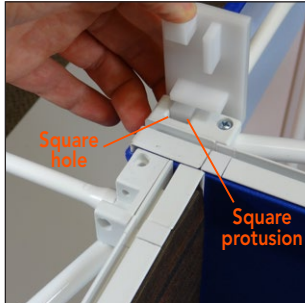

3. Align one square protrusion with the square hole in one hub.

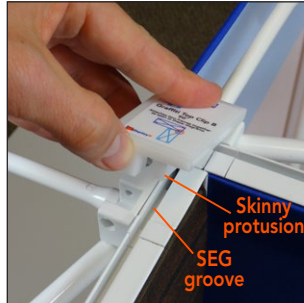

4. Align the skinny protrusion with the SEG groove in the opposite hub.



5. Press the clip firmly down to secure the frames together.

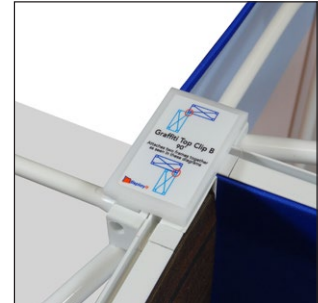

Use the desired clip to connect two frames together as seen in these diagrams:

